



Rocky Mountain Rafts

Raft Measurements

Measurements may vary slightly. Measure YOUR raft before building your frame.

	Length	Width	Rise	Tube Diam.	D-Rings/ Handles	Inside L/W	Flat Area Length	Width c/c	Length c/c	Weight	Inside Depth Top of Tube to top of floor.
SB-90 Cloud 9	9' 2"	60"	27"	18" > 14"	8/2	79"/ 24"	40"	42"	79"	67 lbs	10"

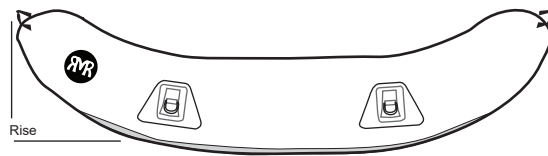
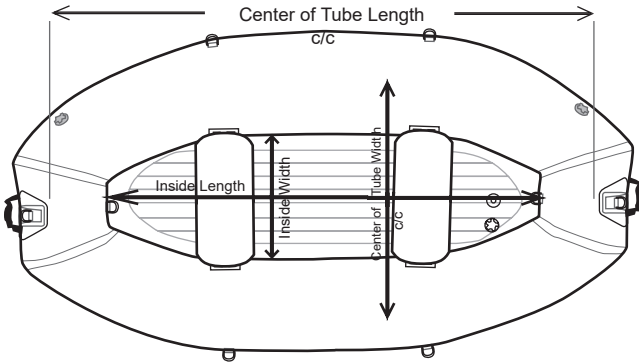

	Length	Width	Rise	Tube Diam.	D-Rings/ Handles	Inside L/W	Flat Area Length	Width c/c	Length c/c	Weight	Inside Depth Top of Tube to top of floor.
SB-95 ThunderCloud	9' 7"	66"	26"	20" > 18.5"	8/2	80"/ 26"	28"	46"	97"	77 lbs	12"

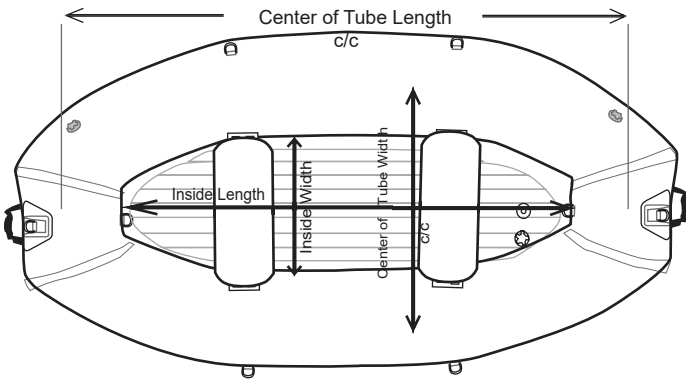

	Length	Width	Rise	Tube Diam.	D-Rings/ Handles	Inside L/W	Flat Area Length	Width c/c	Length c/c	Weight	Inside Depth Top of Tube to top of floor.
SB-105 Storm	10' 6"	62"	27"	18"	8/2	91"/ 26"	56"	45"	110"	102 lbs	10"

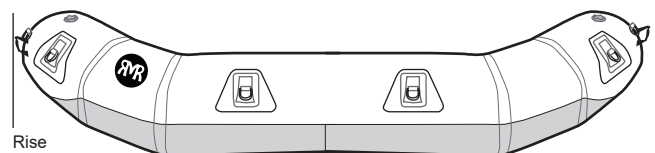
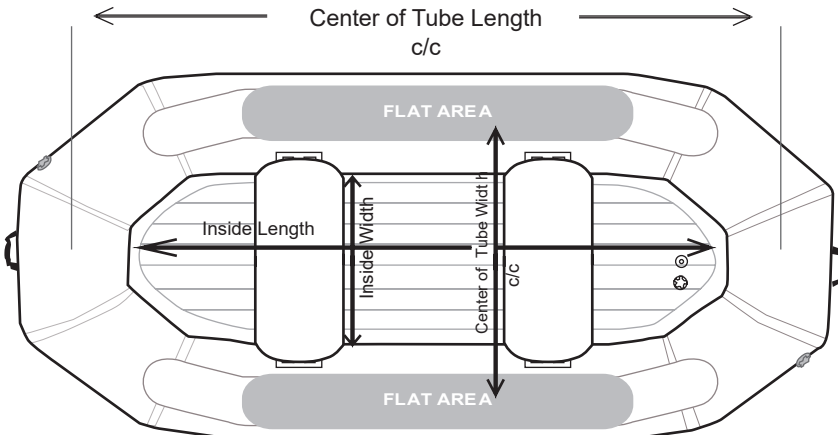

	Length	Width	Rise	Tube Diam.	D-Rings/ Handles	Inside L/W	Flat Area Length	Width c/c	Length c/c	Weight	Inside Depth Top of Tube to top of floor.
SB-120 SBDS-120	12'	74"	27"	18"	12/6	109"/36"	64"	53"	126"	122 lbs	10" SB 12" SBDS

	Length	Width	Rise	Tube Diam.	D-Rings/ Handles	Inside L/W	Flat Area Length	Width c/c	Length c/c	Weight	Inside Depth Top of Tube to top of floor.
SB-130 SBDS-130	12' 10"	75"	28"	19"	12/6	117"/35"	71"	56"	135"	141 lbs	11" SB 13" SBDS

	Length	Width	Rise	Tube Diam.	D-Rings/ Handles	Inside L/W	Flat Area Length	Width c/c	Length c/c	Weight	Inside Depth Top of Tube to top of floor.
SB-140 SBDS-140	14'	85"	29"	20"	12/6	128"/45"	81"	62"	148"	168 lbs	12" SB 14" SBDS

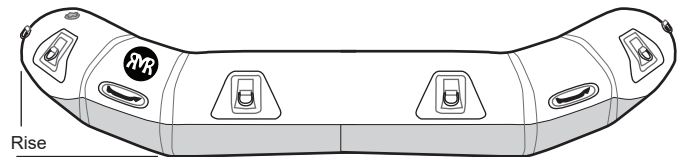
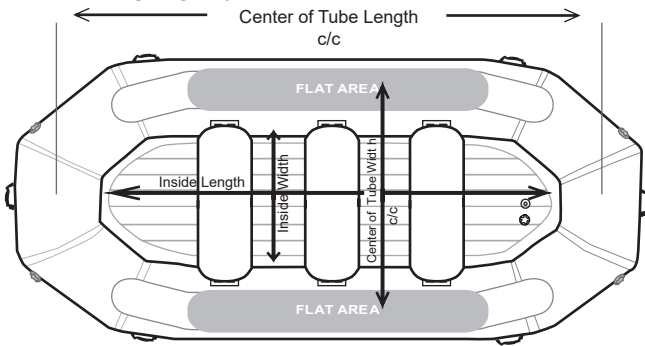

	Length	Width	Rise	Tube Diam.	D-Rings/ Handles	Inside L/W	Flat Area Length	Width c/c	Length c/c	Weight	Inside Depth Top of Tube to top of floor.
SB-160 SBDS-160	16'	92"	31"	22"	12/8	148"/47"	87"	69"	170"	195 lbs	14" SB 16" SBDS

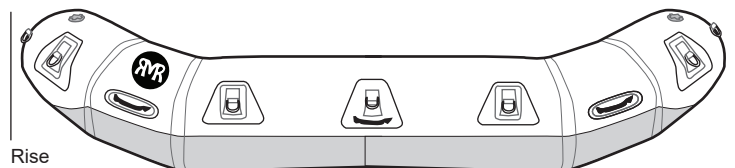
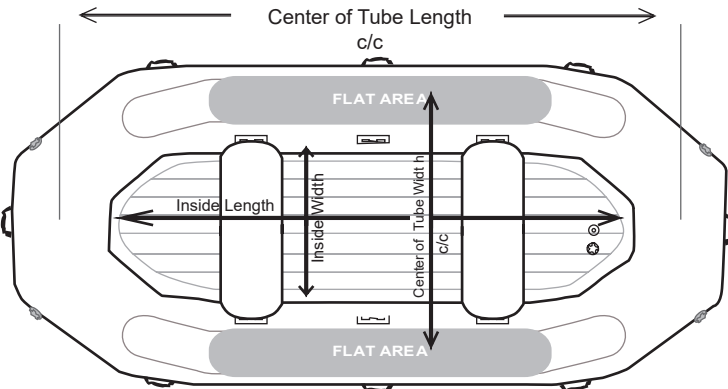

	Length	Width	Rise	Tube Diam.	D-Rings/ Handles	Inside L/W	Flat Area Length	Width c/c	Length c/c	Weight	Inside Depth Top of Tube to top of floor.
SB-180	18'	100.5"	33"	25"	18/2	169"/50"	92"	75"	191"	253 lbs	16"

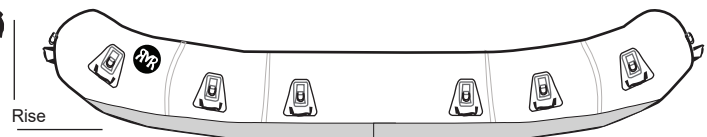
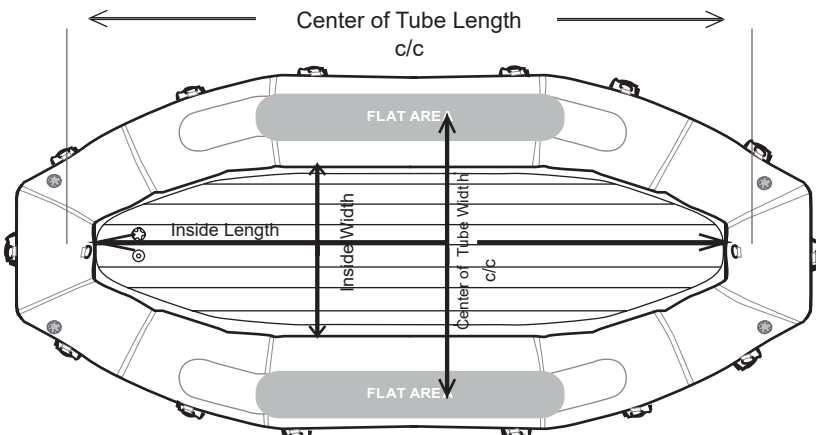

Raft Measurements for Peak Series

	Length	Width	Rise	Tube Diam.	D-Rings/ Handles/ Footcups	Inside L/W	Flat Area Length	Width c/c	Length c/c	Weight	Inside Depth Top of Tube to top of floor.
PK-134	13'4"	73"	31"	20">18"	12/2/2	10'4"/33"	70"	53"	11'10"	140 lbs	10"

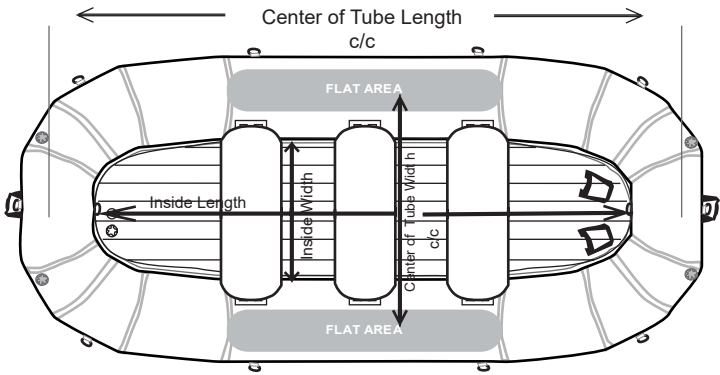

	Length	Width	Rise	Tube Diam.	D-Rings/ Handles/ Footcups	Inside L/W	Flat Area Length	Width c/c	Length c/c	Weight	Inside Depth Top of Tube to top of floor.
PK-135	13' 7"	79"	29"	20">17"	12/2/2	129"/39"	62"	59"	148"	140lbs	10"

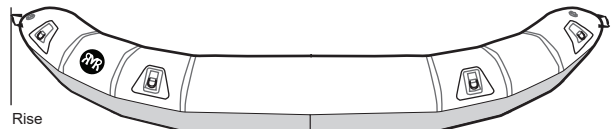
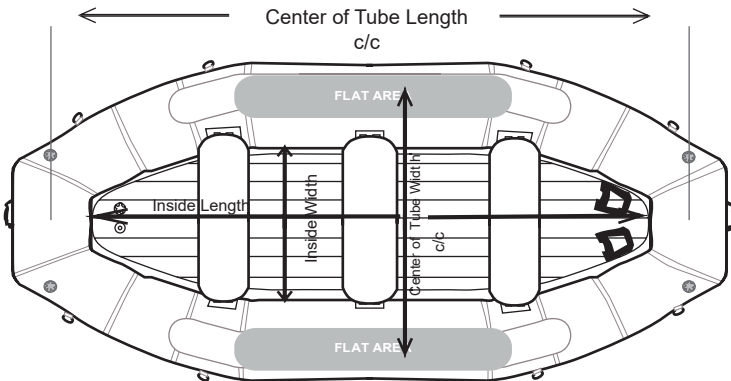

	Length	Width	Rise	Tube Diam.	D-Rings/ Handles/ Footcups	Inside L/W	Flat Area Length	Width c/c	Length c/c	Weight	Inside Depth Top of Tube to top of floor.
PK-159	15'10"	90"	29"	23">20"	16/2/2	150"/44"	68"	67"	171"	199lbs	15"

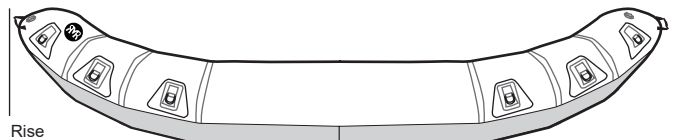
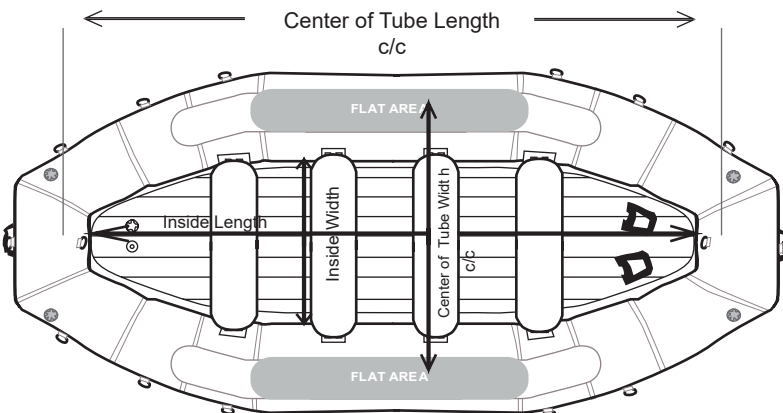

Measurements for IKs

	Length	Width	Kick	Tube Diam.	D-Rings/ Handles	Inside L/W	Width c/c	Length c/c	Weight
IK-123	10' 10"	40"	12"	11"	10/2	108"/18"	29"	119"	35lbs
IK-144	12'	40"	12"	11"	12/2	122"/18"	29"	133"	52lbs

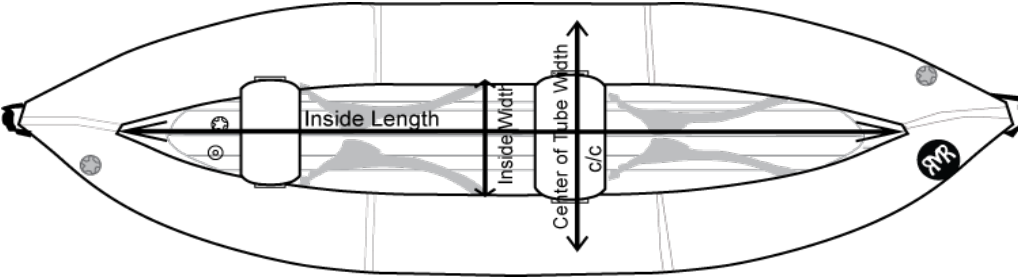
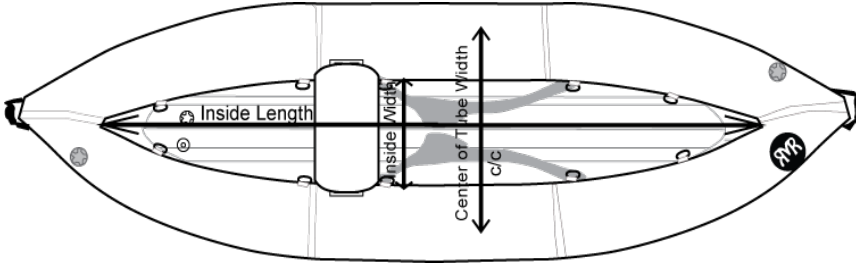

	Length	Width	Kick	Tube Diam.	D-Rings/ Handles	Inside L/W	Width c/c	Length c/c	Weight
IK-126	10' 6"	40"	12"	11"	7/2	104"/18"	29"	115"	28lbs

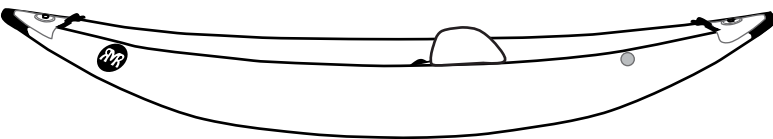
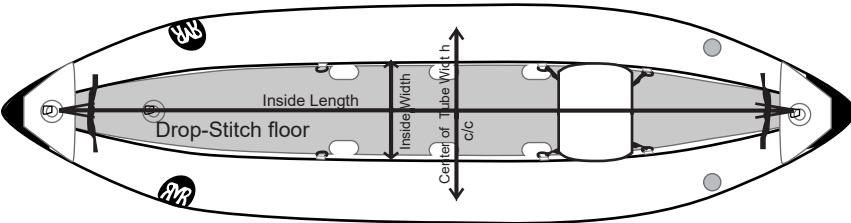

Measurements for PhatCat, Cat Tubes, & River Tubes

	Length	Width	Rise	Tube Diam.	D-Rings/ Footcups	Flat Area Length	Cockpit Width c/c	Cockpit Length c/c	Weight	Inside Depth Top of Tube to top of floor.
PC-120 PhaCat	11'10"	66"	25"	23"	12/2	47"	20"	35"	60 lbs	13"

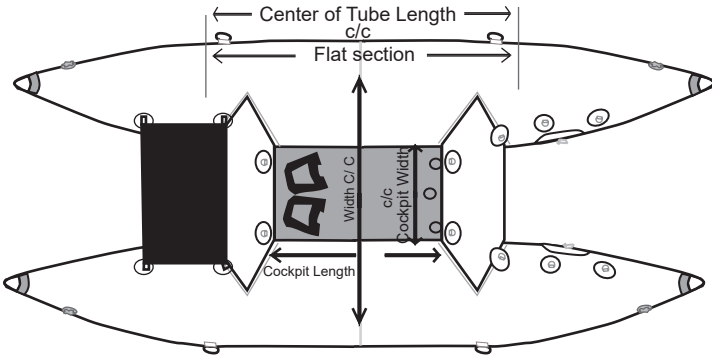

	Length	Tube Diam.	D-Rings/ Handles	Flat Area Length	Weight
CT-140	14'	22"	4/16	95"	82lbs
CT-160	16'	24"	6/16	122"	101lbs

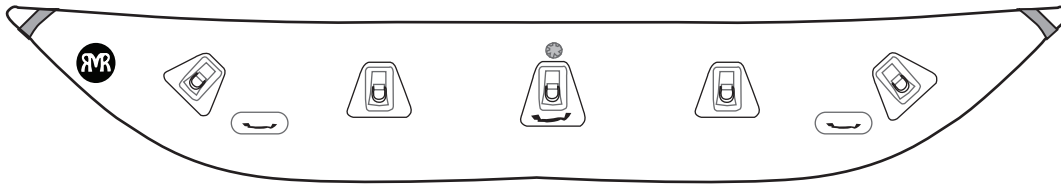
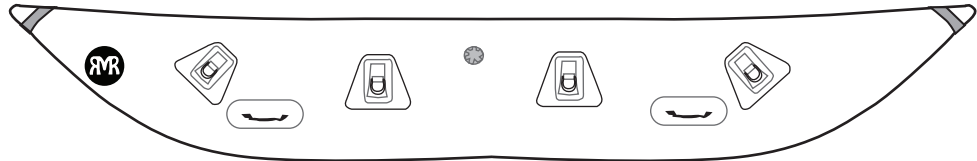

River Tubes	Width	Tube Diam.	D-Rings/ Handles
RTR-44	44"	13"	2/2
RTR-48	48"	15"	2/2

Diminishing River Tubes	Width	Tube Diam.	D-Rings/ Handles
RTD-44	44"	14">11"	2/2
RTD-48	48"	15">12"	2/2

